

PI150 series frequency inverter operation manual

1.Foreword

Thank you for choosing Powtran PI150 series fundamental form frequency inverter.

The diagrams of these operating instructions are used for convenience of explanation and may be slightly different from the product due to product upgrades. Please refer to the actual product.

Please take this manual to the end user and keep it for future maintenance use.

If you have any questions, please get in touch with our company or our agent in time, we will offer dedicated service to you.

2.Instructions on nameplate

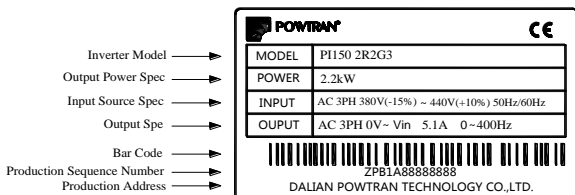

Model designation:

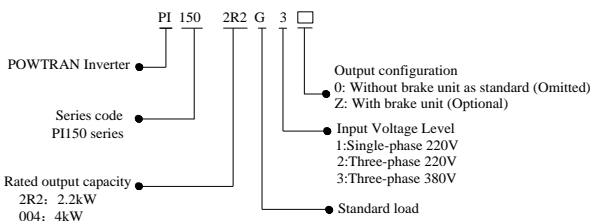

3.Dimension

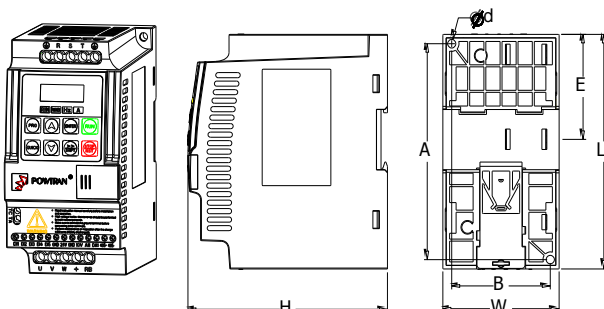

0.75 to 5.5kW G3 support rail mounting

0.75 to 5.5kW G3 dimension

Model	Output power (kW)	Dimension (mm)			Installation (mm)			Guide rail installation position (mm)	Weight(kg)
		L	W	H	A	B	d	E	
PI150 0R4G1(Z)	0.4	138	72	123.5	127	61	5	62	1.1
PI150 0R4G2(Z)	0.4								
PI150 0R7G1(Z)	0.75								
PI150 0R7G2(Z)	0.75								
PI150 0R7G3(Z)	0.75								
PI150 1R5G1(Z)	1.5								
PI150 1R5G2(Z)	1.5								
PI150 1R5G3(Z)	1.5								
PI150 2R2G3(Z)	2.2								
PI150 2R2G1(Z)	2.2								
PI150 2R2G2(Z)	2.2	185	72	134	175	45	5	82	1.3
PI150 004G3(Z)	4								
PI150 5R5G3(Z)	5.5								

4.Operation keyboard introduction

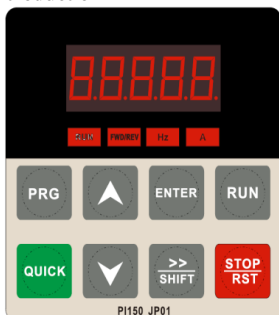









Figure 4-1:Operation panel display

4.1 Keyboard indicator

Indicator light		Name
Status light	RUN	Running indicator light * ON: The inverter is working * OFF: The inverter stops
	FWD/REV	Forward/reverse running light * ON: In forward status * OFF: In reversal status
	Hz	Frequency indicator
	A	Current indicator

4.2 Operation panel button description

Sign	Name	Function
	Parameter setting/esc key	* Enter into the modified status of main menu; * Esc from functional parameter modification; * Esc submenu or functional menu to status menu
	Shift Key	*Choose displayed parameter circularly under running or stop interface; choose parameter's modified position when modify parameter
	Increasing key	* Parameter or function number increasing
	Decreasing key	* Parameter or function number decreasing
	Running key	* For starting running in the mode of keyboard control status
	Stop/Reset key	* For stopping running in the running status; for resetting the operation in fault alarm status. The function of the key is subject to F6.00
	Enter key	* Step by step into the menu screen, set parameters to confirm.
	Quick multi-function key	* This key function is determined by the function code F6.21

5. Standard specifications

Items		Specifications	
Power Input	Rated voltage	AC 1PH 220V(-15%)~240V(+10%) AC 3PH 220V(-15%)~240V(+10%) AC 3PH 380V(-15%) to 440V(+10%)	
	Input frequency	50Hz/60Hz	
	Allowing fluctuations	Voltage continued volatility: $\pm 10\%$ Input frequency fluctuation: $\pm 5\%$	Less than 3% of voltage unbalance rate 3%; Distortion satisfy IEC61800-2 standard
Control system	Control system	High performance vector control inverter based on DSP	
	Control method	V/F control, vector control W/O PG	
	Automatic torque boost function	Realize low frequency (1Hz) and large output torque control under the V/F control mode.	
	Acceleration/deceleration control	Straight or S-curve mode. Four times available and time range is 0.0 to 6500.0s.	
	V/F curve mode	Linear, square root/m-th power, custom V/F curve	
	Over load capability	G type:Rated current 150% - 1 minute, rated current 180% - 2 seconds	
	Maximum frequency	1. Vector control:0 to 300Hz; 2. V/F control:0 to 3200Hz	
	Carrier frequency	0.5 to 16kHz; automatically adjust carrier frequency according to the load characteristics.	
	Input frequency resolution	Digital setting:0.01Hz minimum analog:Maximum frequency*0.025%.	
	Start torque	G type: 0.5Hz/150% (Vector control W/O PG)	
	Speed range	1:100 (Vector control W/O PG)	
	Steady-speed precision	Vector control W/O PG: $\leq \pm 0.5\%$ (Rated synchronous speed)	
	Torque response	$\leq 40\text{ms}$ (Vector control W/O PG)	
	Torque boost	Automatic torque boost; manual torque boost(0.1% to 30.0%)	
	DC braking	The built-in PID adjusts the braking current to ensure sufficient braking torque without over-flow.DC braking frequency: 0.0Hz to max. frequency, braking time:0.0 to 100.0 seconds, braking current value: 0.0% to 100.0%	
Jogging control	Jog frequency range: 0.00Hz to max. frequency; jog Ac/deceleration time: 0.0 to 6500.0s.		
Built-in PID	Easy to realize closed-loop control system for the process control.		
Automatic voltage regulation(AVR)	Automatically maintain a constant output voltage when the voltage of electricity grid changes.		
Speed tracking method	Automatically track current motor speed when the inverter starts		
Personalization function	Self-inspection of peripherals after power-on	After powering on, peripheral equipment will perform safety testing, such as ground, short circuit, etc.	
	Quick current limiting	The current limiting algorithm is used to reduce the inverter over current probability, and improve whole unit anti-interference capability.	
	Timing control	Timing control function: Time setting range(0m to 6500m)	
Running	Input Signal	DI Input terminal	5 digital input terminals
		AI1 analog input	1 analog AI1 input terminal, select 0 to 10V or 0 to 20mA input
		Multi-speed	At most 16-speed can be set(Run by using the multi-function terminals or program)
		Emergency stop	Interrupt controller output
		Fault reset	When the protection function is active, you can automatically or manually reset the fault condition.
	Output Signal	PID feedback signal	Including DC(0 to 10V), DC(0 to 20mA)
		Output terminal	1 way relay output terminal; 1 way DA1 analog output terminal
		Relay output	There are 40 kinds of signals to choose from each way. Contact capacity of the relay: Normally open contact 5A/AC 250V; 5A/DC 30V
		DA1 analog output	1 way analog output, you can select 16 kinds of signals such as frequency, current, voltage, etc. The output signal range can be set arbitrarily within 0 to 10V/0 to 20mA.
Running command channel	Three channels: Operation panel, control terminals and serial communication port. They can be switched through a variety of ways.		
Frequency source	Total 7 frequency sources: Digital, analog voltage, multi-speed, and serial port.		
Run function	Limit frequency, jump frequency, frequency compensation, auto-tuning, PID control		

Protection function	Inverter protection		Overvoltage protection, undervoltage protection, overcurrent protection, overload protection, overheat protection, overcurrent stall protection, overvoltage stall protection, losing-phase protection (Optional), communication error, PID feedback signal abnormalities, and short circuit to ground protection.
Display	LED display keyboard	Running information	Monitoring objects including: Running frequency, set frequency, bus voltage, output voltage, output current, output power, output torque, input terminal status, output terminal status, analog AI1 value, motor Actual running speed, PID set value percentage, PID feedback value percentage.
		Error information	At most save three error message, and the time, type, voltage, current, frequency and work status can be queried when the failure is occurred.
	Key lock and function selection	Lock part or all of keys, define the function scope of some keys to prevent misuse.	
	IGBT temperature	Display current IGBT temperature inside the inverter.	
Communication	RS485	Built-in 485	
Environment	Environment temperature	-10 to 40℃ (The environment temperature in 40 to 50 ℃, please derating use)	
	Storage temperature	-20 to 65 ℃	
	Environment humidity	Less than 90% R.H, no condensation.	
	Vibration	Below 5.9m/s ² (= 0.6g)	
	Application sites	Indoor where no sunlight or corrosive, explosive gas and water vapor, dust, flammable gas, oil mist, water vapor, drip or salt, etc.	
	Altitude	Use below 1000m without derating, 1% for each 100m increasing above 1000m, the highest altitude is 3000m	
	Protection level	IP20	
Product standard	Product adopts safety standards.	IEC61800-5-1:2007	
	Product adopts EMC standards.	IEC61800-3:2005	
Cooling method	Forced air cooling		
Installation method	Rail mounting, wall mounting		

6. Wiring diagram

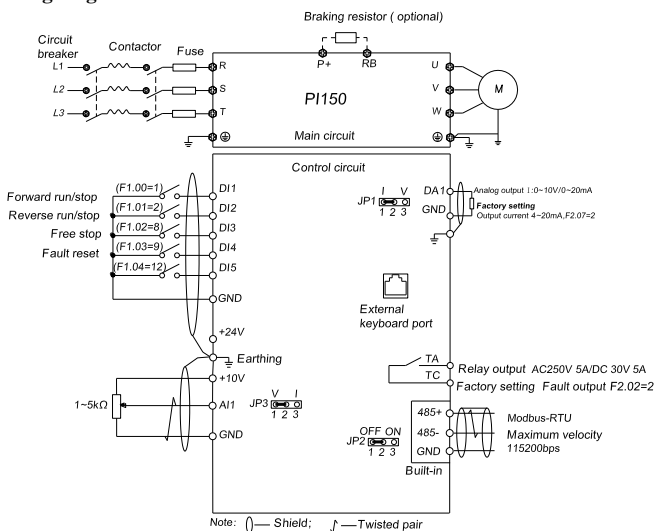

Notes in main circuit wiring

- (1).Wiring specifications, please implement wiring in accordance with electrical regulations;
- (2).Do not connect AC to the output of frequency converter (U, V, W), otherwise the frequency inverter will be damaged;
- (3).Power supply wiring, please try to use isolation line and pipeline, and the isolation line or pipeline ends grounded;
- (4).Frequency inverter grounding wire can not be grounded together with welding machine, high-power motor or high current load, please grounding alone;
- (5).Grounding \oplus please grounding correctly,grounding resistor less than 10Ω.

Notes in wiring control circuit

- (1).Please separate the control signal line from the main circuit line and other power lines;
- (2).To prevent misoperation caused by interference, use twisted or double shielded wires,specification 0.5 to 2mm²;
- (3).Make sure the permissible conditions of each terminal, such as power supply, maximum permissible current, etc;
- (4).The terminal wiring requirements, correct selection of accessories, such as: Voltmeter, input power supply, etc;
- (5).After completing the wiring, please check it correctly and make sure that it is correct before powering it on.

7. Parameter List

In PI150 series frequency inverters ,some parameters are "manufacturer reserved", and their serial numbers are not listed in the function parameter table,which leads to the discontinuity of some parameter serial numbers in the table. For the parameters not introduced in the manual, please do not attempt to modify them to avoid causing errors.

Monitoring function group

Code	Parameter name	Functional Description	Factory setting
d0.00	Running frequency	Inverter theoretical operating frequency	0.01Hz
d0.01	Set frequency	Actual set frequency	0.01Hz
d0.02	DC bus voltage	Detected value for DC bus voltage	0.1V
d0.03	Output voltage	Actual output voltage	1V
d0.04	Output current	Effective value for Actual motor current	0.01A

d0.05	Output power	Calculated value for motor output power	0.1kW
d0.06	Output torque	Motor output torque percentage	0.1%
d0.07	DI input status	DI input status	-
d0.08	DO output status	DO output status	-
d0.09	AII voltage	AII input voltage value	0.01V
d0.12	Count value	Actual pulse count value in counting function	-
d0.13	Length value	Actual length in fixed length function -	-
d0.14	Actual operating speed	Motor actual running speed	-
d0.15	PID setting	Reference value percentage when PID runs	%
d0.16	PID feedback	Feedback value percentage when PID runs	%
d0.17	PLC stage	PLC Stage display when PLC runs	-
d0.19	Feedback speed	Inverter actual output frequency	0.01Hz
d0.20	Remaining run time	Remaining run time display, it is for timing run control	0.1Min
d0.22	Current power-on time	Total time of current inverter power-on	1Min
d0.23	Current run time	Total time of current inverter run	0.1Min
d0.25	Communication set value	Frequency, torque or other command values set by communication port	0.01%
d0.27	Master frequency setting display	Frequency set by F0.03 master frequency setting source	0.01Hz
d0.28	Auxiliary frequency setting display	Frequency set by F0.04 auxiliary frequency setting source	0.01Hz
d0.35	Inverter status	Display the running and standby etc status information	-
d0.36	Inverter type	1:G type: Suitable for constant torque load	-
d0.37	AII voltage before correction	Input voltage value before linear correction of AII	0.01V

Basic Functional Parameter Group

Code	Parameter name	Setting range	Factory setting	Change
F0.00	Motor control mode	0:Vector control without PG ; 2:V/F control	2	★
F0.01	Keyboard set frequency	0.00Hz to F0.19(Maximum frequency)	50.00Hz	☆
F0.02	Frequency command resolution	1: 0.1Hz 2: 0.01Hz	2	★
F0.03	Frequency source master setting	0:Keyboard set frequency(F0.01 ,UP/DOWN can be modified, power-down without memory) 1: Keyboard set frequency(F0.01 ,UP/DOWNcan be modified, power-down with memory); 2:Analog AII setting; 4:Panel potentiometer setting(External keyboard use); 6:Multi-speed operation setting ; 7:Simple PLC program setting; 8:PID control setting; 9:Remote communications setting	1	★
F0.04	Frequency source auxiliary setting	Same as F0.03 setting	0	★
F0.05	Reference object selection for frequency source auxiliary setting	0. Relative to maximum frequency; 1. Relative to master frequency source 1 2. Relative to master frequency source 2	0	☆
F0.06	Frequency source auxiliary setting range	0% to 150%	100%	☆
F0.07	Frequency superimposed selection	Units digit: Frequency source selection; Tens digit: Arithmetic relationship of master and auxiliary for frequency source	00	☆
F0.08	Auxiliary offset frequency	0.00Hz to F0.19 (Maximum frequency)	0.00Hz	☆
F0.09	Shutdown memory selection	0: W/O memory; 1:With memory	1	☆
F0.10	Frequency command UP/DOWN reference when running	0: Running frequency ; 1: Set frequency	0	★
F0.11	Command source selection	0. Keyboard control (LED off); 1.Terminal block control (LED on) 2. Communications command control (LED flashes) 3. Keyboard control+ Communications command control 4.Keyboard control+ Communications command control+ Terminal block control	0	☆
F0.12	Binding frequency source for command source	Units digit: Keyboard command binding frequency source selection 0:Not binded; 1: Keyboard set frequency; 2:AII setting; 4:Panel potentiometer setting (External keyboard) 6:Multi-speed setting; 7:Simple PLC setting; 8:PID setting; 9:Communications reference Tens digit: Terminal command binding frequency source selection (0 to 9, same as units digit) Hundreds digit: Communication command binding frequency source selection (0 to 9, same as units digit)	000	☆
F0.13	Acceleration time1	0.0s to 6500s	Depends on models	☆
F0.14	Deceleration time1	0.0s to 6500s	Depends on models	☆
F0.15	Ac/Deceleration time unit	0:1s; 1:0.1s; 2:0.01s	1	★
F0.16	Ac/deceleration time reference frequency	0:F0.19(Maximum frequency) 1:Set frequency; 2:100Hz	0	★
F0.17	Carrier frequency adjustment	0:NO ; 1: YES	0	☆

F0.18	Carrier Frequency	0.5kHz to 16.0kHz	Depends on models	☆
F0.19	Maximum output frequency	50.00Hz to 320.00Hz	50.00Hz	★
F0.20	Upper limit frequency source	0:F0.21setting; 1:Analog AI1 setting; 5: Communications reference	0	★
F0.21	Upper limit frequency	F0.23 (Lower limit frequency) to F0.19 (Maximum frequency)	50.00Hz	☆
F0.22	Upper limit frequency offset	0.00Hz to F0.19(Maximum frequency)	0.00Hz	☆
F0.23	Lower limit frequency	0.00Hz to F0.21(Upper limit frequency)	0.00Hz	☆
F0.24	Running direction	0: Same direction; 1: Opposite direction	0	☆
F0.26	AIAnalog accuracy	0: 0.01Hz; 1: 0.05Hz; 2: 0.1Hz; 3: 0.5Hz	1	☆

Input terminals

Code	Parameter name	Setting range	Factory setting	Change
F1.00	DI1 terminal function selection	0 to 51	1	★
F1.01	DI2 terminal function selection		2	★
F1.02	DI3 terminal function selection		8	★
F1.03	DI4 terminal function selection		9	★
F1.04	DI5 terminal function selection		0	★

The functions of digital multi-functional input terminal DI1 to DI5 can be set by parameter F1.00 to F1.04. The optional functions are shown in the following table:

Set value	Function	Description
0	No function	The terminal for not use can be set to "no function" to prevent accidental operation.
1	Forward run (FWD)	External terminals are used to control the FWD run mode of inverter.
2	Reverse run (REV)	External terminals are used to control the REV run mode of inverter.
3	Three-wire operation control	This terminal is used to determine the inverter's three-wire control mode. For details, please refer to the instructions of function code F1.10 ("terminal command mode").
4	Forward JOG(FJOG)	FJOG means Forward JOG running, RJOG means Reverse JOG running. For Jog running frequency and Jog Ac/deceleration time, please refer to the description of the function code F7.00, F7.01, F7.02.
5	Reverse JOG(RJOG)	Modify frequency increment/decrement command when the frequency is referenced by external terminal. Adjust up/down the set frequency when the digital setting is selected as the frequency source.
6	Terminal UP	
7	Terminal DOWN	
8	Free stop	The inverter output is blocked, at the time, the parking process of motor is not controlled by the inverter. This way is same as the principle of free stop described in F3.07.
9	Fault reset (RESET)	The function make use of terminal for fault reset. It has same function with RESET key on the keyboard. This function can be used to realize remote fault reset
10	Run pausing	The inverter slows down and stops, but all operating parameters are memorized. Such as PLC parameters, wobble frequency parameters, and PID parameters. This terminal signal disappears, the inverter reverts to the previous state of running before parking
11	External fault normally open input	When the signal is sent to the inverter, the inverter reports fault Err.15, and performs troubleshooting according to fault protection action (for details, please refer to the function code F8.17)
12	Multi-speed terminal 1	The setting of 16 stage speed or 16 kinds of other command can be achieved through the 16 states of the four terminals.
13	Multi-speed terminal 2	
14	Multi-speed terminal 3	
15	Multi-speed terminal 4	
16	Ac/deceleration time selection terminal 1	The selection of 4 ac/deceleration times can be achieved through the 4 states of the two terminals.
17	Ac/deceleration time selection terminal 2	
18	Frequency source switching	Used to switch between different frequency sources. According to the setting of frequency source selection function code (F0.07), the terminal is used to switch between two frequency sources
19	UP/DOWN setting (terminal, keyboard)	When the frequency reference is the digital frequency, this terminal is used to clear the changed frequency value by terminal UP/DOWN or keyboard UP/DOWN, so that the reference frequency can recover to the set value of F0.01
20	Run command switch terminal 1	When the command source is set to the terminal control (F0.11 =1), the terminal can be used to switch between terminal control and keyboard control. When the command source is set to the communication control(F0.11 = 2), the terminal can be used to switch between communication control and keyboard control.
21	Ac/deceleration prohibited	Ensure the inverter is free from external signals affect (Except for shutdown command), maintain current output frequency.
22	PID pause	PID is temporarily disabled, the inverter maintains current output frequency, no longer performs PID adjustment of frequency source.
23	PLC status reset	When PLC pauses and runs again, this terminal is used to reset the inverter to the initial state of simple PLC.
24	Wobble pause	When the inverter outputs at center frequency. Wobble will pause
25	Counter input	Input terminal of the count pulse
26	Counter reset	Clear counter status
27	Length count input	Input terminal of the length count.
28	Length reset	Clear length
32	Immediately DC braking	If the terminal is active, the inverter switches directly to DC braking status
33	External fault normally closed input	When the signal of external fault normally closed input is inputted into the inverter, the inverter will report fault Err.15 and shutdown.
34	Frequency change enable	If the function is set to be valid, when the frequency changes, the inverter does not respond to frequency changes until the terminal state is invalid.
35	PID action direction as reverse	If the terminal is valid, PID action direction opposites to the direction set by E2.03
36	External parking terminal 1	Under keyboard control mode, the terminal can be used to stop the inverter, same as STOP key on the keyboard.
37	Control command switch terminal 2	Used to switch between terminal control and communication control. If the command source is selected as terminal control, the system will be switched to the communication control mode when the terminal is active;

		vice versa.
38	PID integral pause	When the terminal is active, the PID integral adjustment function is paused, but the proportion and differential adjustments of PID are still valid.
39	Switch between frequency source master setting and preset frequency	When the terminal is active, the frequency source A is replaced by the preset frequency (F0.01)
40	Switch between frequency source auxiliary setting and preset frequency	When the terminal is active, the frequency source B is replaced with the preset frequency (F0.01)
43	PID parameter switching	When DI terminal (E2.19 = 1) is used to switch PID parameters, if the terminal is invalid, PID parameters use E2.13 to E2.15; if the terminal is valid, PID parameters use E2.16 to E2.18
44	Custom fault 1	When custom fault 1 and custom fault 2 are active, the inverter respectively alarms fault Err.27 and fault Err.28, and deals with them according to the mode selected by the fault protection action F8.19.
45	Custom fault 2	
47	Emergency parking	If the terminal is valid, the inverter will park at the fastest speed, and the current maintains at the set upper limit during the parking process. This function is used to meet the requirements that the inverter needs to stop as soon as possible when the system is in an emergency state.
48	External parking terminal 2	In any control mode (Keyboard control, terminal control, communication control), the terminal can be used to decelerate the inverter until stop, at the time the deceleration time is fixed for deceleration time 4.
49	Deceleration DC braking	If the terminal is valid, firstly the inverter decelerates to the initial frequency of stop DC braking, and then switches directly to DC braking status.
50	Clear current running time	If the terminal is valid, the inverter's current running time is cleared

Table 1 Multi command functions description: Over 4 segments command terminal, can be combined into 16 states, each state corresponds to the 16 instruction set value. As shown in Table 1 below:

K4	K3	K2	K1	Command Setting	Parameters
OFF	OFF	OFF	OFF	0-Stage speed setting 0X	E1.00
OFF	OFF	OFF	ON	1-Stage speed setting 1X	E1.01
OFF	OFF	ON	OFF	2-Stage speed setting 2X	E1.02
OFF	OFF	ON	ON	3-Stage speed setting 3X	E1.03
OFF	ON	OFF	OFF	4-Stage speed setting 4X	E1.04
OFF	ON	OFF	ON	5-Stage speed setting 5X	E1.05
OFF	ON	ON	OFF	6-Stage speed setting 6X	E1.06
OFF	ON	ON	ON	7-Stage speed setting 7X	E1.07
ON	OFF	OFF	OFF	8-Stage speed setting 8X	E1.08
ON	OFF	OFF	ON	9-Stage speed setting 9X	E1.09
ON	OFF	ON	OFF	10-Stage speed setting 10X	E1.10
ON	OFF	ON	ON	11-Stage speed setting 11X	E1.11
ON	ON	OFF	OFF	12-Stage speed setting 12X	E1.12
ON	ON	OFF	ON	13-Stage speed setting 13X	E1.13
ON	ON	ON	OFF	14-Stage speed setting 14X	E1.14
ON	ON	ON	ON	15 Stage speed setting 15X	E1.15

F1.10	Terminal command mode	0: Two-wire type 1 1; 2: Three-wire type 1; 1: Two-wire type 2 2; 3: Three-wire type 2	0	★
F1.11	Terminal UP/DOWN	0.001Hz/s to 65.535Hz/s	1.000Hz/s	☆
F1.12	Minimum input for AIC1	0.00V to F1.14	0.30V	☆
F1.13	F1.12 corresponding setting	-100.0% to +100.0%	0.0%	☆
F1.14	Maximum input for AIC1	F1.12 to +10.00V	10.00V	☆
F1.15	F1.14 corresponding setting	-100.0% to +100.0%	100.0%	☆
F1.25	A1 input setting selection	Units digit: A11 A11 Below the minimum input setting selection 0: Corresponding to the minimum input set 1:0.0%;	000	☆
F1.30	DI filter time	0.000s to 1.000s	0.010s	☆
F1.31	A11 filter time	0.00s to 10.00s	0.10s	☆
F1.35	DI terminal Mode selection 1	Units digit: DI1 : 0: High level active; 1: Low level active Tens digit: DI2 (Same as the units digit); Hundreds digit: DI3 (Same as the units digit); Thousands digit: DI4 (Same as the units digit); Ten thousands digit: DI5 (Same as the units digit)	00000	★
F1.37	DI1 delay time	0.0s to 3600.0s	0.0s	★
F1.38	DI2 delay time	0.0s to 3600.0s	0.0s	★
F1.39	DI3 delay time	0.0s to 3600.0s	0.0s	★
F1.40	Define the input terminal repeat	0: Unrepeatable; 1: Repeatable	0	★

Output terminal

Code	Parameter name	Setting range	Factory setting	Change
F2.02	Relay output function selection (TA.TC)	0 to 40	2	☆
Relay output function description:				
Setting value	Functions	Description		
0	No output	No output action		
1	Inverter running	Inverter is in running state, the output frequency (Can be zero), the output ON signal.		
2	Fault output (Fault down)	When the drive fails and downtime, the output ON signal.		
3	Frequency level detection FDT1 output	Please refer to the function code F7.23, F7.24's instructions.		
4	Frequency arrival	Please refer to the description of function code F7.25.		
5	Zero-speed running (No output when shutdown)	Inverter operation and the output frequency is 0, output ON signal. When the drive is shut down, the signal is OFF.		
6	Motor overload pre-alarm	Before the motor overload protection, according to the overload pre-alarm threshold value judgment, more than the pre-alarm threshold value output ON signal. Motor overload parameter settings refer to the function code F8.02 to F8.04.		
7	Inverter overload pre-alarm	Before the inverter overload occurs 10s, output ON signal. Setup counter arrive.		

8	Setup counter arrive	When the count reaches the set value of E0.08, output ON signal.
9	Specifies the count value reaches	When the count reaches the set value of E0.09, output ON signal. Counting Function Reference E0 group.
10	Length arrival	When the actual length of the detection of more than E0.05 set length, output ON signal.
11	PLC cycle is complete	After simple PLC completes one cycle, the output of a pulse width of 250ms signal.
12	Total running time arrival	Inverter total running time of more than F7.21 F6.07 set time,the output ON signal.
13	Limited in frequency	When the set frequency exceeds the upper limit frequency or lower frequency, and output frequency is beyond the upper limit frequency or lower limit frequency, output ON signal.
14	Torque limiting	Drive under the speed control mode, when the output torque reaches the torque limit, the inverter is stall protection status, while the output ON signal.
15	Ready to run	When the inverter main circuit and control circuit power supply has stabilized, and the drive does not detect any fault information, the drive is in an operational state, output ON signal.
17	Upper frequency arrival	When the operating frequency reaches the upper frequency,output ON signal.
18	The lower frequency arrival (No output when shutdown)	When the operating frequency reaches the lower frequency, output ON signal. The next stop status signal is OFF.
19	Under voltage state output	When the inverter is in an undervoltage condition, output ON signal.
20	Communication setting	Refer to the communication protocol.
23	Zero-speed operation 2 (Shutdown also output)	The inverter's output frequency is 0, output ON signal. The signal is also ON when shutdown.
24	Cumulative power-on time arrival	When the inverter's accumulated power on time (F6.08) over F7.20 the set time, the output ON signal.
25	Frequency level detection FDT2 output	Please refer to the function code F7.26, F7.27's instructions.
26	Frequency 1 reaches output	Please refer to the function code F7.28, F7.29's instructions.
27	Frequency 2 reaches output	Please refer to the function code F7.30, F7.31's instructions.
28	Current 1 reaches output	Please refer to the function code F7.36, F7.37's instructions.
29	Current 2 reaches output	Please refer to the function code F7.38, F7.39's instructions.
30	Timing reach output	When the timer function selection (F7.42) is valid, the drive time to reach this run after the set time runs out, output ON signal.
31	AI1 input overrun	When the value of analog input AI1 greater than F7.51 (AI1 input protection limit) or less than F7.50 (AI1 input protection under), output ON signal.
33	Off load	When the inverter is off-load state, output ON signal.
34	Reverse operation	Inverter in reverse run, output ON signal
35	0 current state	Refer to the description of function code F7.32, F7.33.
36	Module temperature reaches	Inverter module heatsink temperature (F6.06) reach the set module temperature reaches value (F7.40), output signal ON.
37	Software current limit	Please refer to the function code F7.34, F7.35's instructions.
38	The lower frequency arrival (Stop and output)	When the operating frequency reaches the lower limit frequency, output ON signal. In shutdown state of the signal is also ON.
40	Current running time of arrival	When the inverter starts running time is longer than the time set by F7.45, it outputs ON signal.

F2.07	DA1 output function selection	0 to 17	2	☆
-------	-------------------------------	---------	---	---

Analog Output DA output range is 0V to 10V, or 0mA to 20mA, with the corresponding scaling function relationship in the following table

Setting value	Functions	Description
0	Running frequency	0 to Max. output frequency
1	Set frequency	0 to Max. output frequency
2	Output current	0 to 2 times the motor rated current
3	Output torque	0 to 2 times the motor rated toqure
4	Output power	0 to 2 times rated power
5	Output voltage	0 to 1.2 times inverter rated voltage
7	Analog AI1	0V to 10V(Or 0 to 20mA)
10	Lentgh value	0 to Max. setting length
11	The count value	0 to Max. count value
12	Coummunication set	0.0% to 100.0%
13	Motor speed	0 to Max. output frequency correspondent speed
14	Output current	0.0A to 100.0A(Inverter power ≦ 55kW); 0.0A to 1000.0A(Inverter power>55kW)
15	DC bus voltage	0.0V to 1000.0V
17	Frequency source main set	0 to Max. output frequency

F2.11	Relay 1 output delay time	0.0s to 3600.0s	0.0s	☆
F2.15	DO terminal active status selection	Units digit:Reserve Tens digit:Relay 0:Positive; 1:Negative	00000	☆
F2.16	DA1 zero bias coefficient	-100.0% to +100.0%	20.0%	☆
F2.17	DA1 gain	-10.00 to +10.00	0.8	☆

Start and stop control group

Code	Parameter name	Setting range	Factory setting	Change
F3.00	Start-up mode	0:Direct startup;1:Speed tracking restart 2:Pre-excitation start (AC asynchronous motor)	0	☆
F3.01	Speed tracking mode	3:Hard speed tracking mode	3	★
F3.02	Speed tracking speed	0 to 100	20	☆
F3.03	Start frequency	0.00Hz to 10.00Hz	0.00Hz	☆
F3.04	Hold time for start frequency	0.0s to 100.0s	0.0s	★
F3.05	DC pre-excitation current	0% to 100%	0%	★
F3.06	DC pre-excitation time	0.0s to 100.0s	0.0s	★
F3.07	Stop mode	0:deceleration stop;1: free stop	0	☆
F3.08	DC start frequency	0.00Hz to F0.19(Max.frequency)	0.00Hz	☆
F3.09	DC waiting time	0.0s to 100.0s	0.0s	☆

F3.10	Braking current	0% to 100%	0%	☆
F3.11	Braking time	0.0s to 100.0s	0.0s	☆
F3.12	Braking utilization rate	0% to 100%	100%	☆
F3.13	Ac/deceleration mode	0: Linear acceleration and deceleration; 1: S curve acceleration and deceleration A 2: S curve acceleration and deceleration B	0	★
F3.14	Proportion of S curve start-section	0.0% to (100.0% to F3.15)	30.0%	★
F3.15	Proportion of S curve end-section	0.0% to (100.0% to F3.14)	30.0%	★

V/F control parameter group

Code	Parameter name	Setting range	Factory setting	Change
F4.00	V/F curve setting	0: Linear V/F; 1: Multi-point V/F; 2: Square V/F; 3: 1.2th power V/F; 4: 1.4th power V/F; 6: 1.6th power V/F; 8: 1.8th power V/F; 10: V/F completely separate; 11: V/F half separate	0	★
F4.01	Torque boost	0.0% (Automatic torque boost) 0.1 to 30%	0.0%	★
F4.02	Torque boost cut-off frequency	0.00Hz to F0.19 (Max. Frequency)	15.00Hz	★
F4.03	Multi-point V/F frequency point 1	0.00Hz to F4.05	0.00Hz	★
F4.04	Multi-point V/F voltage point V1	0.0% to 100.0%	0.0%	★
F4.05	Multi-point V/F frequency point 2	F4.03 to F4.07	0.00Hz	★
F4.06	Multi-point V/F voltage point V2	0.0% to 100.0%	0.0%	★
F4.07	Multi-point V/F frequency point 3	F4.05 to b0.04 (Motor rated frequency)	0.00Hz	★
F4.08	Multi-point V/F voltage point V3	0.0% to 100.0%	0.0%	★
F4.09	V/F slip compensation gain	0.0% to 200.0%	0.0%	☆
F4.10	V/F overexcitation gain	0 to 200	80	☆
F4.11	V/F oscillation suppression gain	0 to 100	0	☆
F4.12	V/F separation voltage source	0 to 9	0	☆
F4.13	V/F separation voltage digital setting	0V to motor rated voltage	0V	☆
F4.14	V/F separation voltage rise time	0.0s to 1000.0s	0.0s	☆

Vector control parameter group

Code	Parameter name	Setting range	Factory setting	Change
F5.00	Proportion of speed loop G1	1 to 100	30	☆
F5.01	Speed loop integral T1	0.01s to 10.00s	0.50s	☆
F5.02	Switching frequency 1	0.00 to F5.05	5.00Hz	☆
F5.03	Proportion of speed loop G2	0 to 100	20	☆
F5.04	Speed loop integral T2	0.01s to 10.00s	1.00s	☆
F5.05	Switching frequency 2	F5.02 to F0.19(Max. frequency)	10.00Hz	☆
F5.06	Speed loop integral	0: Invalid; 1: Valid	0	☆
F5.07	Torque limit source under speed control mode	0: Function code F5.08 set; 1: All set; 5: Communication set	0	☆
F5.08	Torque upper limit digital setting	0.0% to 200.0%	150.0%	☆
F5.09	Vector control differential gain	50% to 200%	150%	☆
F5.10	Speed loop filtering time	0.000s to 0.100s	0.000s	☆
F5.11	Vector control overexcitation gain	0 to 200	64	☆
F5.12	Excitation regulator proportional gain	0 to 60000	2000	☆
F5.13	Excitation regulator integral gain	0 to 60000	1300	☆
F5.14	Torque regulator proportional gain	0 to 60000	2000	☆
F5.15	Torque regulator integral gain	0 to 60000	1300	☆

Keyboard and display

Code	Parameter name	Setting range	Factory setting	Change
F6.00	STOP/RESET key functions	0: STOP/RESET key is enabled only under keyboard operation mode 1: STOP/RESET key is enabled under any operation mode	1	☆
F6.01	Running status display parameters 1	0x0000 to 0xFFFF	001F	☆
F6.02	Running status display parameters 2	0x0000 to 0xFFFF	0000	☆
F6.03	Stop status display parameters	0x0001 to 0xFFFF	0033	☆
F6.04	Load speed display coefficient	0.0001 to 6.5000	3.0000	☆
F6.05	Decimal places for load speed display	0: 0 decimal place; 2: 2 decimal place 1: 1 decimal place; 3: 3 decimal place	1	☆
F6.06	Inverter module radiator temperature	0.0°C to 100.0°C	-	●
F6.07	Total running time	0h to 65535h	-	●
F6.08	Total power-on time	0h to 65535h	-	●
F6.09	Total power consumption	0 to 65535°C	-	●
F6.10	Product number	Inverter product number	-	●
F6.11	Software version	Software version of control board	-	●

F6.13	Communication read and write data selection	Single digit: CRC mistake selection: 0: Reply verification error; 1: No reply on verification error; Ten digit: Broadcast message screening selection: 0-no screening; 1-screening Hundred digit: Inverter fault information read selection: 0-read; 1-no read	011	☆
F6.17	Power correction coefficient	0.00 t0 10.00	1.00	☆
F6.20	Keyboard lock selection	0:Only RUN and STOP keys are valid; 2:Only RUN, STOP, UP, DOWN keys are valid; 3:Only STOP key is valid	0	☆
F6.21	QUICK key Function Selection	0:No function; 1:Jog running; 2:Shit key; 3:Forward/reverse running switching; 4: Clear UP/DOWN setting; 5:Free stop; 6: Running command given in sequence	1	☆

Auxiliary function parameter group

Code	Parameter name	Setting range	Factory setting	Change
F7.00	Jog running frequency	0.00Hz t0 F0.19 (Max. frequency)	6.00Hz	☆
F7.01	Jog acceleration time	0.0s t0 6500.0s	5.0s	☆
F7.02	Jog deceleration time	0.0s t0 6500.0s	5.0s	☆
F7.03	Jog priority	0:Invalid; 1:Valid	1	☆
F7.04	Jump frequency 1	0.00Hz t0 F0.19 (Max. frequency)	0.00Hz	☆
F7.05	Jump frequency 2	0.00Hz t0 F0.19 (Max. frequency)	0.00Hz	☆
F7.06	Jump frequency range	0.00Hz t0 F0.19 (Max. frequency)	0.00Hz	☆
F7.07	Jump frequency availability	0:Invalid; 1:Valid	0	☆
F7.08	Acceleration time 2	0.0s t0 6500.0s	Depends on models	☆
F7.09	Deceleration time 2	0.0s t0 6500.0s	Depends on models	☆
F7.10	Acceleration time 3	0.0s t0 6500.0s	Depends on models	☆
F7.11	Deceleration time 3	0.0s t0 6500.0s	Depends on models	☆
F7.12	Acceleration time 4	0.0s t0 6500.0s	Depends on models	☆
F7.13	Deceleration time 4	0.0s t0 6500.0s	Depends on models	☆
F7.14	Switching frequency point between acceleration time 1 and acceleration time 2	0.00Hz t0 F0.19 (Max. frequency)	0.00Hz	☆
F7.15	Switching frequency point between deceleration time 1 and deceleration time 2	0.00Hz t0 F0.19 (Max. frequency)	0.00Hz	☆
F7.16	Forward/reverse rotation dead-band	0.00s t0 3600.0s	0.00s	☆
F7.17	Reverse rotation control	0:Allow; 1:Prohibit	0	☆
F7.18	Mode under lower limit frequency	0: Running at lower limit frequency; 1: Stop; 2: Running at zero speed	0	☆
F7.19	Droop control	0.00Hz t0 10.00Hz	0.00Hz	☆
F7.20	Setting of power-on arrival time	0h t0 36000h	0h	☆
F7.21	Setting of running arrival time	0h t0 36000h	0h	☆
F7.22	Start protection selection	0:OFF; 1:ON	0	☆
F7.23	FDT1 detection value	0.00Hz t0 F0.19 (Max. frequency)	50.00Hz	☆
F7.24	FDT1 detection hysteresis value	0.0% t0 100.0% (FDT1 level)	5.0%	☆
F7.25	Frequency reaches detection width	0.00 t0 100% (Max. frequency)	0.0%	☆
F7.26	FDT2 detection value	0.00Hz t0 F0.19 (Max. frequency)	50.00Hz	☆
F7.27	FDT2 detection hysteresis value	0.0% t0 100.0% (FDT2 level)	5.0%	☆
F7.28	Frequency detection value 1	0.00Hz t0 F0.19 (Max. frequency)	50.00Hz	☆
F7.29	Frequency detection width 1	0.0% t0 100.0% (Max. frequency)	0.0%	☆
F7.30	Frequency detection value 2	0.00Hz t0 F0.19 (Max. frequency)	50.00Hz	☆
F7.31	Frequency detection width 2	0.0% t0 100.0% (Max. frequency)	0.0%	☆
F7.32	0 current detection	0.0% t0 300.0% (Motor rated current)	5.0%	☆
F7.33	0 current delay	0.01s t0 360.00s	0.10s	☆
F7.34	Current over-run value	0.0% (Not detected);0.1% t0 300.0% (Max. frequency)	200.0%	☆
F7.35	Current over-run time	0.00s t0 360.00s	0.00s	☆
F7.36	Arrival current 1	0.0% t0 300.0% (Motor rated current)	100.0%	☆
F7.37	Current 1 width	0.0% t0 300.0% (Motor rated current)	0.0%	☆
F7.38	Arrival current 1	0.0% t0 300.0% (Motor rated current)	100.0%	☆
F7.39	Current 1 width	0.0% t0 300.0% (Motor rated current)	0.0%	☆
F7.40	Module temperature arrival	0°C t0 100°C	75°C	☆
F7.41	Cooling fan control	0: Fan run when inverter is running; 1: Fan keep running	0	☆
F7.42	Timing function selection	0: Invalid; 1: Valid	0	★
F7.43	Timing run time selection	0: F7.44 set; 1: AII set; Note: analog input range correspond to F7.44	0	★
F7.44	Timing run time	0.0Min t0 6500.0Min	0.0Min	★
F7.45	Running time arrive	0.0Min t0 6500.0Min	0.0Min	★
F7.46	Awaken frequency	Dormancy frequency (F7.48) to maximum frequency (F0.19)	0.00Hz	☆

F7.47	Awaken delay time	0.0s t0 6500.0s	0.0s	☆
F7.48	Dormancy frequency	0.00Hz t0 awaken frequency (F7.46)	0.00Hz	☆
F7.49	Dormancy delay time	0.0s t0 6500.0s	0.0s	☆
F7.50	All input voltage protection lower limit	0.00V t0 F7.51	3.1V	☆
F7.51	All input voltage protection upper limit	F7.50 t0 10.00V	6.8V	☆

Fault and protection parameter group

Code	Parameter name	Setting range	Factory setting	Change
F8.00	Overcurrent stall gain	0 to 100	20	☆
F8.01	Lost speed stall protection current	100% to 200%	-	☆
F8.02	Overload protection	0:Prohibit; 1:Allow	1	☆
F8.03	Motor overload protection gain	0.20 to 10.00	1.00	☆
F8.04	Motor overload pre-alarm coefficient	50% to 100%	80%	☆
F8.05	Overvoltage stall gain	0(No overvoltage stall) to 100	0	☆
F8.06	Overvoltage stall protection voltage / energy consumption brake voltage	120% to 150%(Three-phase)	130%	☆
F8.08	Output phase loss protection	0:Prohibit; 1:Allow	1	☆
F8.09	Short to ground protection	0:Invalid; 1:Valid	1	☆
F8.10	Number of automatic fault reset	0 t0 32767	0	☆
F8.11	Fault DO action selection during automatic fault	0:OFF ; 1:ON	0	☆
F8.12	Automatic fault reset	0.1s t0 100.0s	1.0s	☆
F8.25	Abnormal reserve frequency	60.0% t0 100.0%	100%	☆
F8.26	Momentary power cut action selection	0: Invalid; 1: Deceleration; 2: Deceleration and stop	0	☆
F8.28	Recovery voltage judgment time of momentary power cut	0.00s t0 100.00s	0.50s	☆
F8.29	Judgment voltage of momentary power cut	50.0% t0 100.0%(Standard bus voltage)	80%	☆

Communication parameter group

Code	Parameter name	Setting range	Factory setting	Change
F9.00	Baud rate	Unit:Modbus 2:1200BPS; 3:2400BPS; 4:4800BPS; 5:9600BPS; 6:19200BPS; 7:38400BPS; 8:57600BPS; 9:115200BPS Tens digit: Reserved; Hundreds digit : Reserved Thousands digit:Reserved	6005	☆
F9.01	Data format	0:No parity (8-N-2); 1:Even parity (8-E-1) 2:Odd parity (8-O-1) 3:No parity (8-N-1)	0	☆
F9.02	This unit address	1 t0 250 ,for broadcast address	1	☆
F9.03	Response delay	0ms t0 20ms	2ms	☆
F9.04	Communication timeout time	0.0(Invalid);0.1 t0 60.0s	0.0	☆
F9.05	Data transfer format selection	Units digit:Modbus 0: Non-standard Modbus protocol; 1:Stand Modbus protocol Tens digit: Reserved	31	☆
F9.06	Communication read current resolution	0:0.01A ; 1:0.1A	0	☆

Control parameter optimization group

Code	Parameter name	Setting range	Factory setting	Change
Fb.00	Fast current limiting manner	0:Disable; 1: Enable	1	☆
Fb.01	Undervoltage point setting	50.0% t0 140.0%	100.0%	☆
Fb.02	Overvoltage point setting	200.0 t0 2500.0V	-	★
Fb.03	Deadband compensation mode selection	0: No compensation; 1:Compensation mode 1; 2: Compensation mode 2	1	☆
Fb.04	Current detection compensation	0 t0 100	5	☆
Fb.05	Vector optimization without PG mode selection	0: No compensation; 1: Compensation mode 1; 2: Compensation mode 2	1	★
Fb.06	Upper limiting frequency for DPWM switching	0.00 t0 15.00Hz	12.00Hz	☆
Fb.07	PWM modulation mode	0:Asynchronous; 1:Synchronous	0	☆
Fb.08	Random PWM depth	0:Invalid 1 t0 10:PWM carrier frequency random depth	0	☆

Wobble, fixed-length and counting group

Code	Parameter name	Setting range	Factory setting	Change
E0.00	Swing setting manner	0:Relative to center frequency; 1: Relative to maximum Frequency	0	☆
E0.01	Wobble range	0.0% t0 100.0%	0.0%	☆
E0.02	Sudden jump frequency range	0.0% t0 50.0%	0.0%	☆
E0.03	Wobble cycle	0.1s t0 3000.0s	10.0s	☆
E0.04	Triangle wave rise time coefficient	0.1% t0 100.0%	50.0%	☆
E0.05	Set length	0m t0 65535m	1000m	☆
E0.06	Actual length	0m t0 65535m	0m	☆
E0.07	Pulse per meter	0.1 t0 6553.5	100.0	☆
E0.08	Set count value	1 t0 65535	1000	☆

E0.09	Specified count value	1 t0 65535	1000	☆
-------	-----------------------	------------	------	---

Multi-speed, sample PLC parameter

Code	Parameter name	Setting range	Factory setting	Change
E1.00	0 stage speed setting 0X	-100.0% t0 100.0%	0.0%	☆
E1.01	1 stage speed setting 1X	-100.0% t0 100.0%	0.0%	☆
E1.02	2 stage speed setting 2X	-100.0% t0 100.0%	0.0%	☆
E1.03	3 stage speed setting 3X	-100.0% t0 100.0%	0.0%	☆
E1.04	4 stage speed setting 4X	-100.0% t0 100.0%	0.0%	☆
E1.05	5 stage speed setting 5X	-100.0% t0 100.0%	0.0%	☆
E1.06	6 stage speed setting 6X	-100.0% t0 100.0%	0.0%	☆
E1.07	7 stage speed setting 7X	-100.0% t0 100.0%	0.0%	☆
E1.08	8 stage speed setting 8X	-100.0% t0 100.0%	0.0%	☆
E1.09	9 stage speed setting 9X	-100.0% t0 100.0%	0.0%	☆
E1.10	10 stage speed setting 10X	-100.0% t0 100.0%	0.0%	☆
E1.11	11 stage speed setting 11X	-100.0% t0 100.0%	0.0%	☆
E1.12	12 stage speed setting 12X	-100.0% t0 100.0%	0.0%	☆
E1.13	13 stage speed setting 13X	-100.0% t0 100.0%	0.0%	☆
E1.14	14 stage speed setting 14X	-100.0% t0 100.0%	0.0%	☆
E1.15	15 stage speed setting 15X	-100.0% t0 100.0%	0.0%	☆
E1.16	PLC Simple PLC running mode	0:Stop after single running; 1: Hold final value after single 2: Circulating	0	☆
E1.17	PLCmemory selection	Units:power-down memory; 0:Power-down without memory; 1:Power-down memory; Tens:stop with memory;; 0:Stop without memory; 1:Stop memory	11	☆
E1.18	0 stage running time T0	0.0s(h) t0 6500.0s(h)	0.0s(h)	☆
E1.19	0 stage ac/deceleration time selection	0:F0.13, F0.14; 1:F7.08, F7.09; 2:F7.10, F7.11; 3:F7.12, F7.13	0	☆
E1.20	1 stage running time T1	0.0s(h) t0 6500.0s(h)	0.0s(h)	☆
E1.21	1 stage ac/deceleration time selection	Same to E1.19	0	☆
E1.22	2 stage running time T2	0.0s(h) t0 6500.0s(h)	0.0s(h)	☆
E1.23	2 stage ac/deceleration time selection	Same to E1.19	0	☆
E1.24	3 stage running time T3	0.0s(h) t0 6500.0s(h)	0.0s(h)	☆
E1.25	3 stage ac/deceleration time selection	Same to E1.19	0	☆
E1.26	4 stage running time T4	0.0s(h) t0 6500.0s(h)	0.0s(h)	☆
E1.27	4 stage ac/deceleration time selection	Same to E1.19	0	☆
E1.28	5 stage running time T5	0.0s(h) t0 6500.0s(h)	0.0s(h)	☆
E1.29	5 stage ac/deceleration time selection	Same to E1.19	0	☆
E1.30	6 stage running time T6	0.0s(h) t0 6500.0s(h)	0.0s(h)	☆
E1.31	6 stage ac/deceleration time selection	Same to E1.19	0	☆
E1.32	7 stage running time T7	0.0s(h) t0 6500.0s(h)	0.0s(h)	☆
E1.33	7 stage ac/deceleration time selection	Same to E1.19	0	☆
E1.34	8 stage running time T8	0.0s(h) t0 6500.0s(h)	0.0s(h)	☆
E1.35	8 stage ac/deceleration time selection	Same to E1.19	0	☆
E1.36	9 stage running time T9	0.0s(h) t0 6500.0s(h)	0.0s(h)	☆
E1.37	9 stage ac/deceleration time selection	Same to E1.19	0	☆
E1.38	10 stage running time T10	0.0s(h) t0 6500.0s(h)	0.0s(h)	☆
E1.39	10 stage ac/deceleration time selection	Same to E1.19	0	☆
E1.40	11 stage running time T11	0.0s(h) t0 6500.0s(h)	0.0s(h)	☆
E1.41	11 stage ac/deceleration time selection	Same to E1.19	0	☆
E1.42	12 stage running time T12	0.0s(h) t0 6500.0s(h)	0.0s(h)	☆
E1.43	12 stage ac/deceleration time selection	Same to E1.19	0	☆
E1.44	13 stage running time T13	0.0s(h) t0 6500.0s(h)	0.0s(h)	☆
E1.45	13 stage ac/deceleration time selection	Same to E1.19	0	☆
E1.46	14 stage running time T14	0.0s(h) t0 6500.0s(h)	0.0s(h)	☆
E1.47	14 stage ac/deceleration time selection	Same to E1.19	0	☆
E1.48	15 stage running time T15	0.0s(h) t0 6500.0s(h)	0.0s(h)	☆
E1.49	15 stage ac/deceleration time selection	Same to E1.19	0	☆
E1.50	Simple PLC run-time unit	0:S(s); 1:H(h)	0	☆
E1.51	Multi-stage command 0 reference manner	0: Function code E1.00 reference 1: Analog AI1 reference; 5: PID control setting; 6:Keyboard set frequency (F0.01) setting, UP/DOWN can be modified	0	☆

PIDfunction parameter group

Code	Parameter name	Setting range	Factory setting	Change
E2.00	PIDsetting source	0: E2.01 setting; 1: Analog AI1 reference 5: Communications reference; 6: Multi-stage command reference	0	☆
E2.01	PIDkeyboard reference	0.0% t0 100.0%	50.0%	☆
E2.02	PIDfeedback source	0: Analog AI1 given; 5: Communications given;	0	☆
E2.03	PIDaction direction	0:Positive; 1:Negative	0	☆

E2.04	PIDsetting feedback range	0 t0 65535	1000	☆
E2.05	PIDinversion cutoff frequency	0.00 t0 F0.19(Maximum frequency)	0.00Hz	☆
E2.06	PIDdeviation limit	0.0% t0 100.0%	2.0%	☆
E2.07	PIDdifferential limiting	0.00% t0 100.00%	0.10%	☆
E2.08	PIDreference change time	0.00s t0 650.00s	0.00s	☆
E2.09	PIDfeedback filter time	0.00s t0 60.00s	0.00s	☆
E2.10	PIDoutput filter time	0.00s t0 60.00s	0.00s	☆
E2.11	PIDfeedback loss detection value	0.0%:Not judged feedback loss;0.1% t0 100.0%	0.0%	☆
E2.12	PID feedback loss detection time	0.0s to 20.0s	0.0s	☆
E2.13	Proportional gain KP1	0.0 to 200.0	80.0	☆
E2.14	Integration time Ti1	0.01s to 10.00s	0.50s	☆
E2.15	Differential time Td1	0.00s to 10.000s	0.000s	☆
E2.16	Proportional gain KP2	0.0 to 200.0	20.0	☆
E2.17	Integration time Ti2	0.01s to 10.00s	2.00s	☆
E2.18	Differential time Td2	0.00 to 10.000	0.000s	☆
E2.19	PID parameter switfching conditions	0: No switching; 1: Switching via terminals 2: Automatically switching according to deviation.	0	☆
E2.20	PID parameter switching deviation 1	0.0% to E2.21	20.0%	☆
E2.21	PID parameter switching deviation 2	E2.20 to 100.0%	80.0%	☆
E2.22	PID integral properties	Units digit: Integral separation 0: Invalid; 1: Valid Tens digit: Whether stop integration when output reaches limit 0: Continue; 1: Stop	00	☆
E2.23	PID initial value	0.0% to 100.0%	0.0%	☆
E2.24	PID initial value hold time	0.00s to 360.00s	0.00s	☆
E2.25	Maximum deviation of twice outputs(Forward)	0.00% to 100.00%	1.00%	☆
E2.26	Maximum deviation of twice outputs(Backward)	0.00% to 100.00%	1.00%	☆
E2.27	Computing status after PID stop	0: Stop without computing 1: Stop with computing	1	☆
E2.29	PID automatic decrease frequency selection	0:Invalid; 1:Valid	1	☆
E2.30	PID stop frequency	0.00Hz to maximum frequency(F0.19)	25	☆
E2.31	PID checking time	0s to 3600s	10	☆
E2.32	PID checking times	10 to 500	20	☆

Motor parameters

Code	Parameter name	Setting range	Factory setting	Change
b0.00	Motor type selection	0: General asynchronous motor 1: Asynchronous inverter motor	0	★
b0.01	Rated power	0.1kW to 1000.0kW	Depends on models	★
b0.02	Rated voltage	1V to 2000V	Depends on models	★
b0.03	Rated current	0.01A to 655.35A (Inverter power ≤ 55kW) 0.1A to 6553.5A (Inverter rate> 55kW)	Depends on models	★
b0.04	Rated frequency	0.01Hz to F0.19 (Maximum frequency)	Depends on models	★
b0.05	Rated speed	1rpm to 36000rpm	Depends on models	★
b0.06	Asynchronous motor stator resistance	0.001Ω to 65.535Ω (Inverter power ≤ 55kW) 0.0001Ω to 6.5535Ω (Inverter power> 55kW)	Motor parameters	★
b0.07	Asynchronous motor rotor resistance	0.001Ω to 65.535Ω (Inverter power ≤ 55kW) 0.0001Ω to 6.5535Ω (Inverter power> 55kW)	Motor parameters	★
b0.08	Asynchronous motor leakage inductance	0.01mH to 655.35mH (inverter power ≤ 55kW) 0.001mH to 65.535mH (inverter power> 55kW)	Motor parameters	★
b0.09	Asynchronous motor mutual inductance	0.1mH to 6553.5mH (Inverter power ≤ 55kW) 0.01mH to 655.35mH (Inverter power> 55kW)	Motor parameters	★
b0.10	Asynchronous motor no-load current	0.01A to b0.03 (Inverter power ≤ 55kW) 0.1A to b0.03 (Inverter power> 55kW)	Motor parameters	★
b0.27	Motor parameter auto tuning	0: No operation 1: Asynchronous motor parameters still auto tuning 2: Asynchronous motor parameters comprehensive auto tuning	0	★

Function code management

Code	Parameter name	Setting range	Factory setting	Change
y0.00	Parameter initialization	0: No operation 1:Restore default parameter values, not including motor parameters 2: Clear history 3: Restore default parameter values, including motor parameters 4: Backup current user parameters 5: Restore from backup user parameters	0	★
y0.01	User password	0 to 65535	0	☆
y0.02	Function parameter group display selection	Units digit: d group display selection 0: Not displays 1: Displays Tens digit: E group display selection(The same above)	11111	★

		Hundreds digit:b group display selection(The same above) Thousands digit:y group display selection(The same above) Tens thousands digit:L group display selection(The same above)		
y0.03	Personality parameter group display selection	Units digit:Reserved Tens digit :User's change parameter display selection 0:Not display 1:Display	00	☆
y0.04	Function code modification properties	0: Modifiable 1: Not modifiable	0	☆

Fault query parameter group

Code	Parameter name	Setting range	Factory setting	Change
y1.00	Type of the first fault	0: No fault	-	●
y1.01	Type of the second fault	1: Inverter unit protection 2: Acceleration overcurrent 3: Deceleration overcurrent 4: Constant speed overcurrent 5: Acceleration overvoltage 6: Deceleration overvoltage 7: Constant speed overvoltage 8: Control power failure 9: Undervoltage 10: Inverter overload 11: Motor Overload 12: Input phase loss 13: Output phase loss 14: Module overheating 15: External fault 16: Communication abnormal 17: Contactor abnormal 18: Current detection abnormal 19: Motor self-learning abnormal 20: Encoder/PG card abnormal 21: Parameter read and write abnormal 22: Inverter hardware abnormal 23: Motor short to ground 24: Reserved 25: Reserved 26: Running time arrival 27: Custom fault 1 28: Custom fault 2 29: Power-on time arrival 30: Load drop 31: PID feedback loss when running 40: Fast current limiting timeout 41: Switch motor when running 42: Too large speed deviation 43: Motor overspeed 45: Motor over-temperature 51: Initial position error COF: communication failure	-	●
y1.02	Type of the third(At last) fault		-	●
y1.03	Frequency of the third(At last) fault	-	-	●
y1.04	Current of the third(At last) fault	-	-	●
y1.05	Bus voltage of the third(At last) fault	-	-	●
y1.06	Input terminal status of the third(At last) fault	-	-	●
y1.07	Output terminal status of the third(At last) fault	-	-	●
y1.08	Reserved	-		
y1.09	Power-on time of the third(At last) fault		-	●
y1.10	Running time of the third(At last) fault	-	-	●
y1.13	Frequency of the second fault		-	●
y1.14	Current of the second fault	-	-	●
y1.15	Bus voltage of the second fault	-	-	●
y1.16	Input terminal status of the second fault	-	-	●
y1.17	Output terminal status of the second fault	-	-	●
y1.19	Power-on time of the second fault		-	●
y1.20	Running time of the second fault	-	-	●
y1.23	Frequency of the first fault		-	●
y1.24	Current of the first fault	-	-	●
y1.25	Bus voltage of the first fault	-	-	●
y1.26	Input terminal status of the first fault	-	-	●
y1.27	Output terminal status of the first fault	-	-	●
y1.29	Power-on time of the first fault		-	●
y1.30	Running time of the first fault		-	●

8. Fault alarm and countermeasures

PI150 can provide effective protection when the equipment performance is played fully. In case of abnormal fault, the protection function will be invoked, the inverter will stop output, and the faulty relay contact of the inverter will start, and the fault code will be displayed on the display panel of the inverter. Before consulting the service department, user can perform self-check , analyze the fault cause and find out the solution according to the instructions of this chapter. If the fault is caused by the reasons as described in the dotted frame, please consult the agents of inverter or directly contact with our company.

No.	Fault ID	Failure type	Possible causes	Solutions
1	Err.01	Inverter unit protection	1.The short circuit of inverter output happens 2.The wiring for the motor and the inverter is too long 3.Module overheating 4.The internal wiring of inverter is loose 5.The main control panel is abnormal 6.The drive panel is abnormal. 7.The inverter module is abnormal	1.Eliminate peripheral faults 2.Additionally install the reactor or the output filter 3.Check the air duct is blocked or not and the fan is working normally or not, and eliminate problems 4.Correctly plug all cables 5.Seek for technical support

2	Err.02	Acceleration overcurrent	<ol style="list-style-type: none"> 1.The acceleration time is too short 2.Manual torque boost or V/F curve is not suitable 3.The voltage is low 4.The short-circuit or earthing of inverter output happens 5.The control mode is vector and without identification of parameters 6.The motor that is rotating is started unexpectedly. 7.Suddenly increase the load in the process of acceleration. 8.The type selection of inverter is small 	<ol style="list-style-type: none"> 1.Increase acceleration time 2.Adjust manual torque boost or V/F curve 3.Set the voltage to the normal range 4.Eliminate peripheral faults 5.Perform identification for the motor parameters 6.Select Speed Tracking Start or restart after stopping the motor. 7.Cancel the sudden load 8.Choose the inverter with large power level
3	Err.03	Deceleration overcurrent	<ol style="list-style-type: none"> 1.The short-circuit or earthing of inverter output happens 2.The control mode is vector and without identification of parameters 3.The deceleration time is too short 4.The voltage is low 5.Suddenly increase the load in the process of deceleration. 6.didn't install braking unit and braking resistor 	<ol style="list-style-type: none"> 1.Eliminate peripheral faults 2.Perform identification for the motor parameters 3.Increase the deceleration time 4.Set the voltage to the normal range 5.Cancel the sudden load 6.Install braking unit and brake resistor
4	Err.04	Constant speed overcurrent	<ol style="list-style-type: none"> 1.The short-circuit or earthing of inverter output happens 2.The control mode is vector and without identification of parameters 3.The voltage is low 4, Whether suddenly increase the load when running 5.The type selection of inverter is small 	<ol style="list-style-type: none"> 1.Eliminate peripheral faults 2.Perform identification for the motor parameters 3.Set the voltage to the normal range 4.Cancel the sudden load 5.Choose the inverter with large power level
5	Err.05	Acceleration overvoltage	<ol style="list-style-type: none"> 1.Didn't install braking unit and braking resistor 2.The input voltage is high 3.There is external force to drag the motor to run when accelerating. 4.The acceleration time is too short 	<ol style="list-style-type: none"> 1.Install braking unit and brake resistor 2.Set the voltage to the normal range 3.Cancel the external force or install braking resistor. 4.Increase acceleration time
6	Err.06	Deceleration overvoltage	<ol style="list-style-type: none"> 1.The input voltage is high 2.There is external force to drag the motor to run when decelerating. 3.The deceleration time is too short 4.Didn't install braking unit and braking resistor 	<ol style="list-style-type: none"> 1.Set the voltage to the normal range 2.Cancel the external force or install braking resistor. 3.Increase the deceleration time 4.Install braking unit and brake resistor
7	Err.07	Constant speed overvoltage	<ol style="list-style-type: none"> 1. There is external force to drag the motor to run when running 2.The input voltage is high 	<ol style="list-style-type: none"> 1.Cancel the external force or install braking resistor. 2.Set the voltage to the normal range
8	Err.08	Control power failure	The range of input voltage is not within the specification	Adjust the voltage to the range of the requirements of specification
9	Err.09	Under voltage fault	<ol style="list-style-type: none"> 1.The momentary power cut 2.The inverter's input voltage is not within the specification 3.The bus voltage is not normal 4.The rectifier bridge and buffer resistance are abnormal 5.The drive panel is abnormal. 6.The control panel is abnormal 	<ol style="list-style-type: none"> 1.Reset fault 2.Adjust the voltage to the normal range 3.Seek for technical support
10	Err.10	Inverter overload	<ol style="list-style-type: none"> 1.The type selection of inverter is small 2.Whether the load is too large or the motor stall occurs 	<ol style="list-style-type: none"> 1.Choose the inverter with large power level 2.Reduce the load and check the motor and its mechanical conditions
11	Err.11	Motor Overload	<ol style="list-style-type: none"> 1. Power grid voltage is too low 2.Whether the setting motor protection parameters (F8.03) is appropriate or not 3.Whether the load is too large or the motor stall occurs 	<ol style="list-style-type: none"> 1.Check the power grid voltage 2.Correctly set this parameter. 3.Reduce the load and check the motor and its mechanical conditions
13	Err.13	Output phase loss	<ol style="list-style-type: none"> 1.The lead wires from the inverter to the motor is not normal 2.The inverter's three phase output is unbalanced when the motor is running 3.The drive panel is abnormal. 4.The module is abnormal 	<ol style="list-style-type: none"> 1.Eliminate peripheral faults 2.Check the motor's three-phase winding is normal or not and eliminate faults 3.Seek for technical support
14	Err.14	Module overheating	<ol style="list-style-type: none"> 1.The air duct is blocked 2.The fan is damaged 3.The ambient temperature is too high 4.The module thermistor is damaged 5.The inverter module is damaged 	<ol style="list-style-type: none"> 1.Clean up the air duct 2.Replace the fan 3.Decrease the ambient temperature 4.Replace the thermistor 5.Replace the inverter module
15	Err.15	External equipment fault	Input external fault signal through the multi-function terminal DI	Reset run
16	Err.16	Communication fault	<ol style="list-style-type: none"> 1.The communication cable is not normal 2.The settings for communication expansion card F9.07 are incorrect 3.The settings for communication parameters F9 group are incorrect 4.The host computer is not working properly 	<ol style="list-style-type: none"> 1.Check the communication cable 2.Correctly set the communications expansion card type 3.Correctly set the communication parameters 4.Check the wiring of host computer
17	Err.17	Contact fault	<ol style="list-style-type: none"> 1.Input phase loss 2.The drive plate and the contact are not normal 	<ol style="list-style-type: none"> 1.Check and eliminate the existing problems in the peripheral line 2.replace the drive, the power board or contactor
18	Err.18	Current detection fault	<ol style="list-style-type: none"> 1.Check Hall device 2.The drive panel is abnormal. 	<ol style="list-style-type: none"> 1.replace the drive panel 2.replace hall device
19	Err.19	Motor parameter auto tuning fault	<ol style="list-style-type: none"> 1.The motor parameters was not set according to the nameplate 2.The identification process of parameter is timeout 	<ol style="list-style-type: none"> 1.Correctly set motor parameter according to the nameplate 2.Check the lead wire from the inverter to the motor
21	Err.21	EEPROM read and write fault	EEPROM chip is damaged	Replace the main control panel
22	Err.22	Inverter hardware fault	<ol style="list-style-type: none"> 1.overvoltage 2.overcurrent 	<ol style="list-style-type: none"> 1.Eliminate overvoltage fault 2.Eliminate overcurrent fault
23	Err.23	Short-circuit to ground fault	Motor short to ground	Replace the cable or motor
26	Err.26	Cumulative	Cumulative running time arrival fault	Clear history information by using

		running time arrival fault		initialization function parameters
27	Err.27	Custom fault 1	Input custom fault 1 signal through the multi-function terminal DI	Reset run
28	Err.28	Custom fault 2	Input custom fault 2 signal through the multi-function terminal DI	Reset run
29	Err.29	Total power-on time arrival fault	Total power-on time reaches the set value	Clear history information by using initialization function parameters
31	Err.31	PID feedback loss when running fault	PID feedback is less than the set value of E2.11	Check PID feedback signal or set E2.11 to an appropriate value
40	Err.40	Quick current limiting fault	1.Whether the load is too large or the motor stall occurs 2.The type selection of inverter is small	1.Reduce the load and check the motor and its mechanical conditions 2.Choose the inverter with large power level
42	Err.42	Too large speed deviation fault	1.The setting for Too Large Speed Deviation parameters(F8.15, F8.16) is unreasonable. 2.The setting for encoder parameters is incorrect 3.The parameter was not identified	1.Reasonably set the detection parameters 2.Correctly set encoder parameters 3.Perform identification for the motor parameters
51	Err.51	Initial position error	The deviation between the motor parameters and the actual parameters is too large	Reconfirm the correct motor parameters, focus on whether the rated current is set to too small.
-	COF	Communication failure	1.Keyboard interface control board interface; 2.Keyboard or crystal connector; 3.Control board or keyboard hardware damage; 4.Keyboard line is too long, causing the interference.	1.Detection of keyboard interface, control board interface is abnormal. 2.Detect keyboard, crystal joints are abnormal. 3.Replace control board or keyboard. 4. Consult factory, seek help.

PI150 标准英文说明书 V2.0 20190724E